



Extra information for ...Max actuators – size M

for optimization of planning, installation and initial startup for safe operation



Assembly

- ▶ Dimensions, drill plate
- ▶ Control elements: switch – push buttons – LED
- ▶ Outdoor installation
- ▶ Mounting on air dampers (form-fit)
- ▶ Mounting on fire dampers (form-fit)
- ▶ Mounting on butterfly valves and ball valves
- ▶ Mounting of terminal box ...Box and auxiliary switch ...Switch



Electric

- ▶ Power supply design
- ▶ Line cross sections
- ▶ Problem treatment/error indication

Subject to change!

▶ Dimensions

Dimensioning in mm

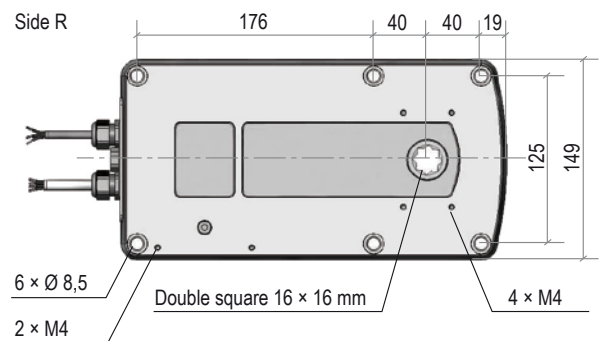
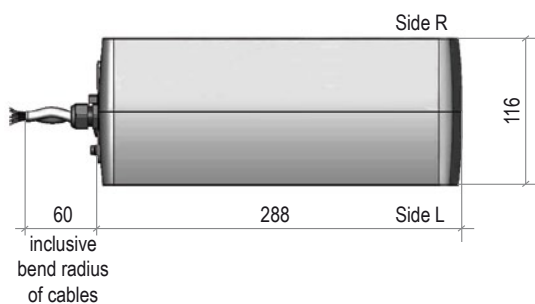

▶ Control elements: switch – push button – LED

All actuators are equipped with a 10-position switch, a push button and a multicolour LED for calibration. These control elements are to be found cable-laterally behind the two middle sectioned dummy plugs. For operation these must be removed. The calibration can be achieved despite lining up power supply at the actuator. The explosion prevention is not impaired thereby. However, it has to be of great concern that the dummy plugs must be rescrewed in order to comply with the IP-protection class.

The operation of the switch and button has to be done by means of a small screwdriver. Force with strong pressure and /or rotation is to be avoided in any case, since otherwise control electronics can be damaged irreparably. Adjustments of torque and running time can be achieved also before mounting. The adjustment of angle of rotation can be started only with an outside load and accurate mounting.

Switch – Push button – Lamp for adjustment (behind the blanking plug)

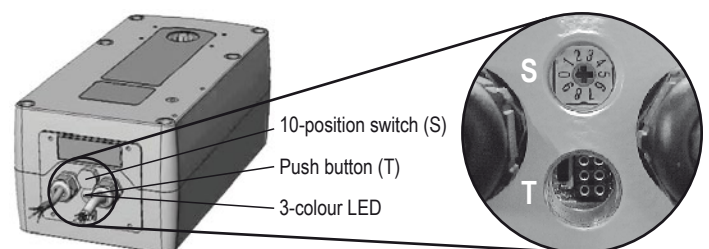

▶ Outdoor installation

When mounting actuator outdoors it has to be certain that the actuator is protected against direct sun exposure (heat and UV!), rain and snow by employing an enclosure roof. Supply voltage is to be applied immediately after mounting in order to assure integrated heating at start.

Since actuators must have an internal temperature fuse, they may not be exposed to a too high temperature, neither at storage nor during operation. Otherwise the fuse could respond and switch off the actuator irreversibly.

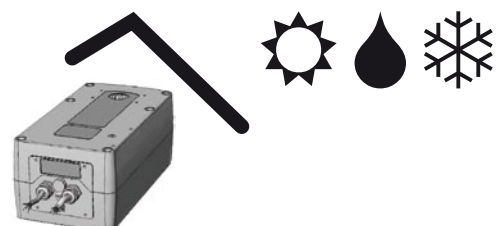

► **Mounting of ...Max actuators on air dampers**



...Max actuators size M are equipped with a 16 × 16 mm (double square) shaft connection by default.
The form-fitting shaft connection is the most secure connection between damper shaft

and actuator because slipping or slipping through is avoided compared to the force-fit clamp-connection. The actuator will be connected firmly to the damper by means of four screws M8 × 140 mm (scope of supply).

Form fitting shaft connection – Mounting on square damper shaft

It is to be considered that the actuators have a total angle movement of approx. 95° in order to realize a pretension on the damper. Therefore the actuator sits tilted on the damper shaft.

In order to prevent this and to assure pretension to the damper the driving shaft has to be adjusted mechanically before connecting to the damper shaft. The provided socket wrench serves for mechanical adjustment over the hand-operated control socket "HV". For mounting actuator's "side R" the manual override has to be turned **clockwise**, mounting "side L" **counterclockwise**.

The actuators are axially symmetric developed. In case of spring return function the safety position must be selected by turning the actuator to 180°.

Mounting:

1. Affix tap holes M8 (in accordance with drill template) on the damper or to a mounting bracket
2. Adjust drive shaft of the actuator with the socket wrench that the drive stands perpendicularly to the damper before plugging actuator onto the damper shaft
3. Plug actuator onto damper shaft and fix diagonally with 2 screws
4. Remove the socket wrench
5. Pivot and tighten the remaining screws

Note:

The drive shaft is selflocking produced and may only be mechanically adjusted either with the provided socket wrench or the optional accessory "HV-MK" manual override (turn off power supply). External force applied to the shaft can lead to mechanical damage of the actuator!

Dimension of the damper shaft

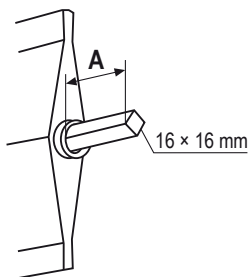

Length A

Measure A in acc. with indicator:

- | | |
|--|---------------------|
| 1. Actuator without indicator | A = no limit |
| 2. Actuator with indicator, no accessories | A < 95 mm |

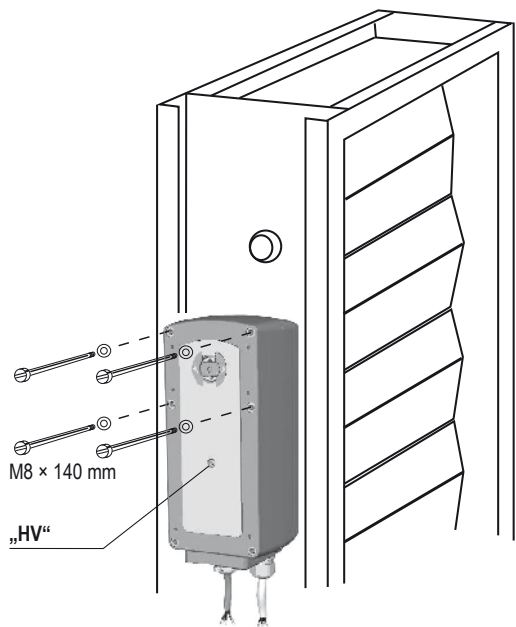

4 screws M8 × 140 mm as well as a socket wrench are part of delivery.
For square damper shafts 12 × 12 mm or 14 × 14 mm reducing bushes are available as optional accessories.

► **Mounting of ...Max... actuators on fire dampers**



...Max actuators size M are equipped with a 16 × 16 mm (double square) form-fitting shaft connection. The form-fitting shaft connection is the securest connection between damper shaft and actuator. The actuator is fixed with four screws directly to the fire damper and/or fixed to a mounting bracket.

ExMax-...-BF and RedMax-...-BF actuators integrate an intrinsically safe circuit in order to connect an ExPro-TT-... sensor which works like a temperature trigger. InMax-... and InPro-TT-... are for non hazardous areas.

Form-fitted shaft connection – Mounting on square damper shaft

It is to be considered that the actuators have a total angle movement of approx. 95° in order to realize a pretension on the damper. Therefore the actuator sits tilted on the damper shaft.

For mounting actuator's "side R" the manual override has to be turned **clockwise**, mounting "side L" **counterclockwise**.

In order to prevent this and to generate pretension the driving shaft has to be adjusted mechanically before connecting to the damper shaft. The provided socket wrench serves for mechanical adjustment over the hand-operated control socket "HV".

The actuators are axially symmetric developed. In case of spring return function the safety position must be selected by turning the actuator to 180°.

Mounting:

1. Affix tap holes M8 (in accordance with drill template) on the damper or to a mounting bracket
2. Adjust drive shaft of the actuator with the socket wrench that the drive stands perpendicularly to the damper before plugging actuator onto the damper shaft
3. Plug actuator onto damper shaft and fix diagonally with 2 screws
4. Remove the socket wrench
5. Pivot and tighten the remaining screws
6. Mount temperature trigger ...Pro-TT-...
7. Mount terminal box (type ...Box-BF)
8. Plug sensor connector into actuator's socket

Note:

The drive shaft is selflockingly produced and may only be mechanically adjusted either with the provided socket wrench or the optional accessory "HV-MK" manual override (turn off power supply). External force applied to the shaft can lead to mechanical damage of the actuator!

Connection of safety temperature trigger ...Pro-TT-...



The temperature trigger is mounted directly to the duct or damper wall with pre-assembled tapping screws. The position of the safety elements must guarantee free air flow. ...Pro-TT-... is mounted to the actuator by means of quick fastener M12.



► **Mounting of ...Max... actuators to ball valves and butterfly valves**



Actuators of size M are equipped by default with a 16 × 16 mm double square form-fitting shaft connection. For mounting to butterfly valves or ball valves a special mounting bracket in acc. with DIN EN ISO 5211 is required.

Since this standard provides only certain basic conditions there can be substantial geometrical differences between armatures which require a special adaption.

Mounting to a ball valve

Mounting to a butterfly valve

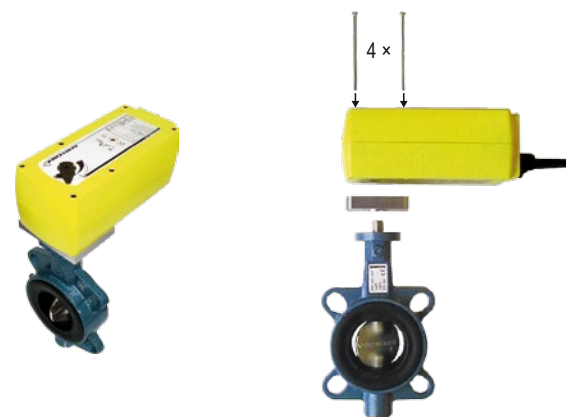
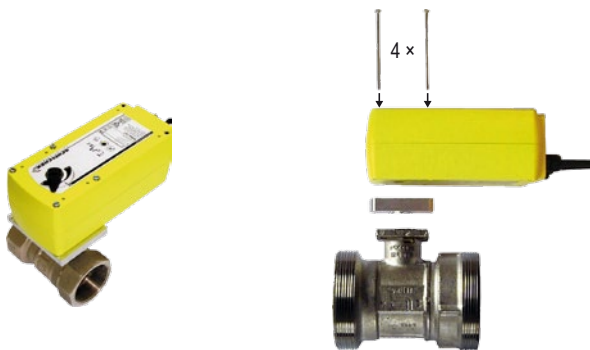

► **Mounting of terminal boxes ...Box to actuator via mounting bracket MKK-M (accessory)**

- A) Screw mounting bracket MKK-M with 4 screws to actuator
- B) Screw terminal box to mounting bracket

Mounting bracket can be mounted every 90°

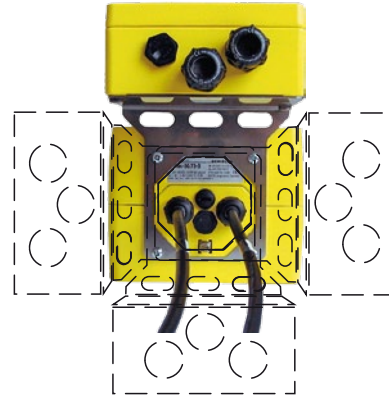
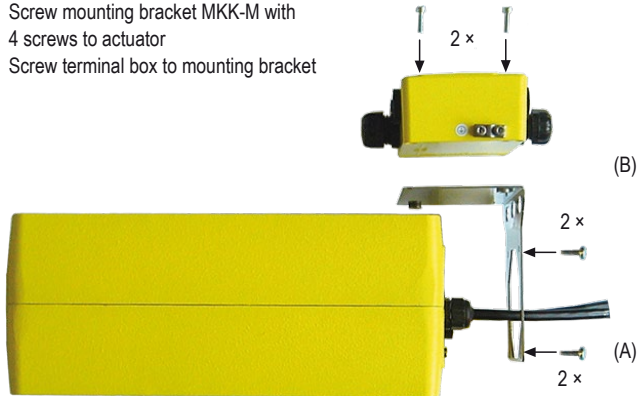

Terminal box mounted above the actuator

Terminal box mounted beside the actuator

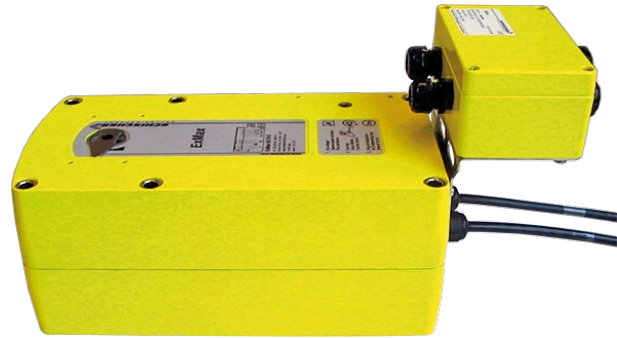
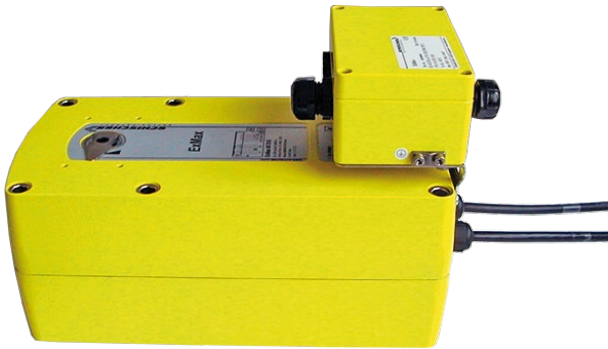

► **Mounting of auxiliary switch ...Switch to actuator**

- A) Place square connection part on actuator's shaft
- B) Mount ...Switch and fix it with screws

...Max with mounted ...Switch

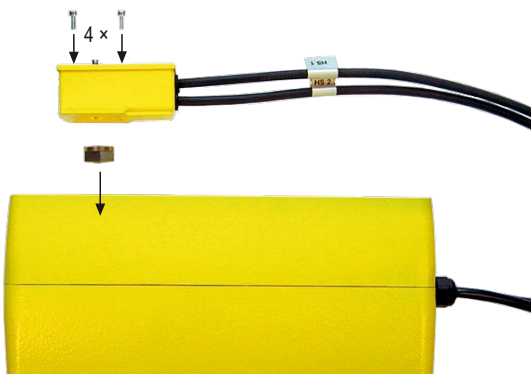

(B)

(A)



► Power input depending on supply voltage

The design of the on-site supply depends on the selected motor running time and selected supply voltage. Accompanying values are "about values" since there can be construction unit dispersions within electronics. The holding power is run time independently typical at ~ 5 W. The power consumption for the heater is ~ 16 W. In the heating phase the motor is not active!

The initial starting supply voltage required by the actuators power supply unit is ~ 2.0 A. The starting pulse takes about 1 sec. (please consider this while conceiving the cross section of the supply line). The power factor is between 0.8 and 0.5 in dependence of motor running time. A line protection should be min. 2 AT.

Voltage	Current	Rated current in acc. with motor running time				
		40 s	60 s	90 s	120 s	150 s
24 VDC	I _{Nominal}	1,5 A	1,0 A	0,8 A	0,7 A	0,7 A
120 VAC	I _{Nominal}	0,26 A	0,18 A	0,14 A	0,12 A	0,12 A
240 VAC	I _{Nominal}	0,13 A	0,09 A	0,07 A	0,06 A	0,06 A

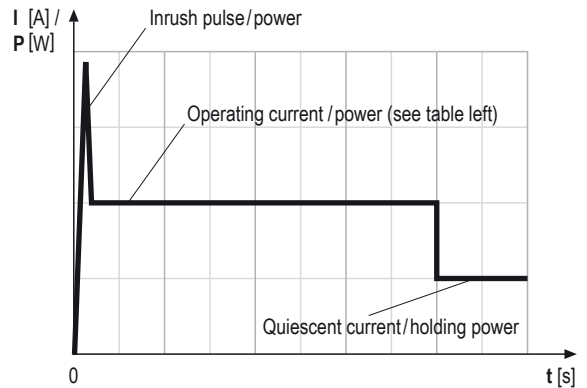

► Cross sections of the inlet line

On long distances between voltage supply and drive, voltage drops occur due to line resistances. As a consequence with 24 VAC/DC the actuator receives a too low tension and does not start. In order to prevent this the cross section of the inlet line is to be dimensioned accordingly.

The accompanying formulas allow the calculation of the necessary line cross section respectively maximal permitted conduit length respectively utilizing the existing line cross section.

Alternatively the secondary voltage can be increased by selecting a transformer.

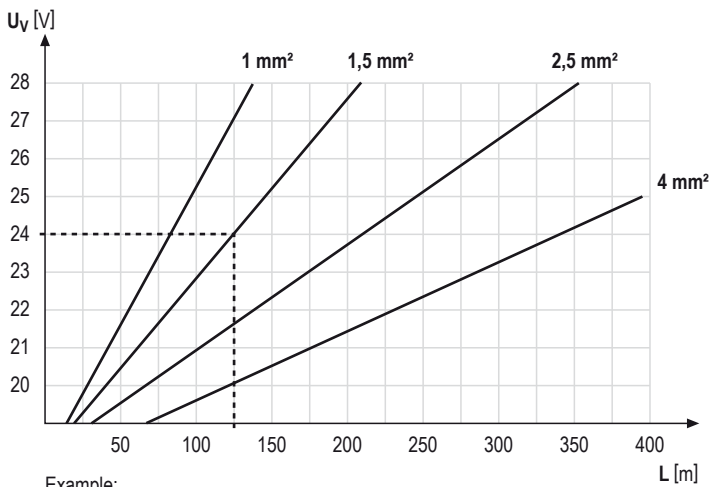
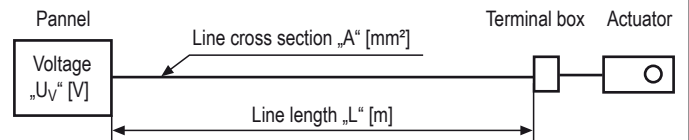

Example:
24 V power supply with wire diameter 1.5 mm² = cable length 126 m

Required **cable cross section A** at existing cable length L

$$A = 0,0714 \times L : (U_V - 18 V)$$

Example: L = 250 m, U_V = 30 V
Cross section A = 1,5 mm²

Maximum **cable length L** at existing cross section A

$$L = A \times (U_V - 18 V) : 0,0714$$

Example: A = 1.5 mm², U_V = 24 V
Length of cable L = 126 m

For calculation following characteristics are essential:

- U_V = supply voltage [V]
- A = line cross section [mm²]
- L = conduit length [m]
- Factor 0.0714 = drive specific factor [Vmm²/m]
(based on the electrical conductivity of electrolytic copper with a coefficient of 56 m/Ωmm²)

► Problem handling / Error indication



Problem	Possible cause	Course of action
01 Actuator does not work LED does not light	<ul style="list-style-type: none"> No power supply attached The actuator is operated at ambient temperature beyond specifications and the internal temperature fuse shuts down irreversibly 	<ul style="list-style-type: none"> Attach power supply and turn on Caused by inadmissible operation and for safety relevant reasons the actuator drove into an irreversible condition and must be exchanged. accompanying new installation the ambient temperature has to be reduced accordingly
02 Actuator does not work LED lights RED	<ul style="list-style-type: none"> The actuator is operated at a too high ambient temperature and the internal temperature sensor responded ...-BF actuators require a temperature trigger type ...Pro-TT or FireSafe 	<ul style="list-style-type: none"> Shut off actuator and let temperature decrease, reduce ambient temperature by suitable measures e.g. ventilation or other mounting position of the actuator Connect trigger, LED changes to GREEN, actuator is ready-to-operate
03 Actuator does not work LED lights GREEN	<ul style="list-style-type: none"> 3-pos. control signal is wired on both entrances Required torque is greater than actuators torque Control signals are not attached or attached on a wrong conductor Actuator is incorrectly mounted and is blocked by an external stop unit Interchanged supply lines 	<ul style="list-style-type: none"> Readjust / correct circuit Adjust a higher torque at the actuator if possible otherwise exchange for a type with higher torque Examine rule and adjusting signals and connect in accordance with diagram Dismount actuator and testdrive without load for operability. Then install actuator accordingly so that the power transmission of the actuator runs the armature/damper without external blockade or torsion Switch wires: 1 must be connected to (-, N) and wire 2 to (+, L)
04 Actuator does not work LED is blinking RED	<ul style="list-style-type: none"> The actuator has been mounted at temperatures < -20 °C and did not reach its operating temperature of at least -20 °C 	<ul style="list-style-type: none"> Ensure that a constant voltage supply is applied on conductor 1–2 Wait until the required operating temperature is achieved by the actuators internal heating system. The actuator will start operating independently
05 Y-drive in 3-pos. mode cannot gear into intermediate positions	<ul style="list-style-type: none"> The conversion of constant mode to 3-pos. mode was not set 	<ul style="list-style-type: none"> Recalibrate the actuator in accordance with assembly instructions
06 Actuator sits diagonally on square damper shaft	<ul style="list-style-type: none"> Actuators have an angle of rotation of 95° incl. 5° pretension. While assembling the pre-load was not considered 	<ul style="list-style-type: none"> Dismount actuator off the damper, use enclosed socket wrench to draw up approx. 5° over the hand operated control device before remounting on the damper shaft. Consider assembly instructions!
07 A modulating Y-actuator working with reduced angle of rotation, reaches its end positions already at > 0 V/4 mA resp. < 10 V/20 mA	<ul style="list-style-type: none"> At start up no self-adjustment of angle of rotation was accomplished 	<ul style="list-style-type: none"> Accomplish self adjustment of angle of rotation in accordance with assembly instruction
08 LED flashes irregularly and actuator does not work	<ul style="list-style-type: none"> Actuator does not receive sufficient supply voltage Cable to long, voltage drop in the supply line to large 	<ul style="list-style-type: none"> Increase line cross section or power supply Increase line cross section or power supply